

TOOLS FOR ARCHITECTS...

i n n o^{.fi}



- Inno, founded 1975
- Inno Interior Oy: mother company, modern design furniture
- Inno-Tuote Oy: daughter company, interior accessories

inno^{fi}



TOOLS FOR ARCHITECTS...

The aim of the collection is to provide architects and interior designers different looking and useful interior objects as tools for modern interiors.

inno^{fi}

Designers:



Harri Korhonen, Interior architect



Jouni Leino, Interior architect



Ari Kanerva, Designer



Susanne Grönlund, Designer



Mikko Laakkonen, Designer



Teppo Asikainen, Designer



Tomi Kapiainen, Designer



Timo Vierros, Designer



Julie Tolvanen, Designer



Steinar Hindenes, Designer



Simo Heikkilä, Interior architect



Jouko Järvisalo, Interior architect

"We strongly believe that a good product has to give more than a look and a function, it has to feel right"

inno^{fi}



O

Ono is a light wooden chair with welcoming design language rooting strongly to the Scandinavian design tradition giving the chair a touch of history. The construction is obvious in its own way, the back carries and lifts the seat from the frame giving the chair a light and inviting expression.

Design: Susanne Grønlund



- a comfortable and light wooden chair with welcoming design language
- the opening in the backrest makes the handling of the chair easy
- launched in Stockholm 2017

Design: Susanne Grønlund

inno^{fi}



- light looking, sculptural wooden small chair for dining and meeting purposes
- available with or without seat upholstery and an optional back pillow
- 2015 GOOD DESIGN™ award

Design: Julie Tolvanen

inno^{fi}



harmonious and cozy 2-seater sofa. Its rounded
perfect for creating peaceful interiors.
light back the tempting and elegant Aura
as a divider. The disclosed structure
characteristic and interesting.



- a harmonious and cozy sofa and chair family
- red dot: best of the best award 2013
- 2015 GOOD DESIGN™ award



Design: Mikko Laakkonen

inno^{fi}



• Aura Wood is a natural extension to the award-winning family launched in 2016

Design: Mikko Laakkonen

inno^{fi}



LAB



- Lab XL is a comfortable easy chair
- continuation to the cozy convention of Lab series
- the softness of the chair has been created through a plain quilted seat

Design: Harri Korhonen

inno^{fi}

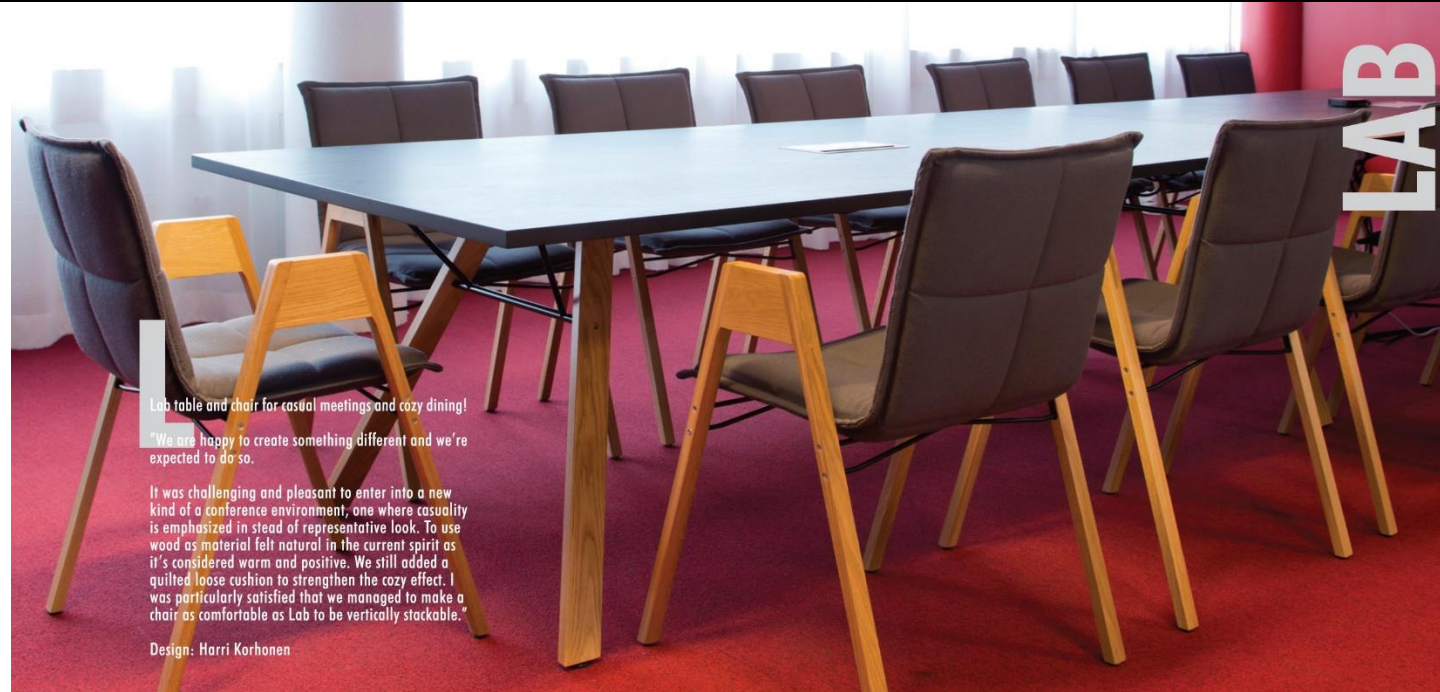

Lab table and chair for casual meetings and cozy dining!

"We are happy to create something different and we're expected to do so."

It was challenging and pleasant to enter into a new kind of a conference environment, one where casuality is emphasized instead of representative look. To use wood as material felt natural in the current spirit as it's considered warm and positive. We still added a quilted loose cushion to strengthen the cozy effect. I was particularly satisfied that we managed to make a chair as comfortable as Lab to be vertically stackable."

Design: Harri Korhonen



- table and chair series for casual meetings & cozy dining
- individual or modular table that can be extended endlessly
- Lab Meeting was launched in Milan 2016
- 2015 GOOD DESIGN™ award



Design: Harri Korhonen

inno.fi



- Lab bar table and chair in two heights
- Lab table system is available in several sizes and heights and cable management options

Design: Harri Korhonen

inno^{fi}

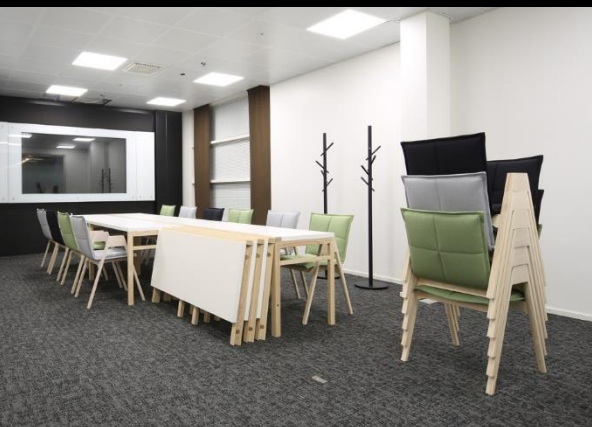

CHAIR: INTRO

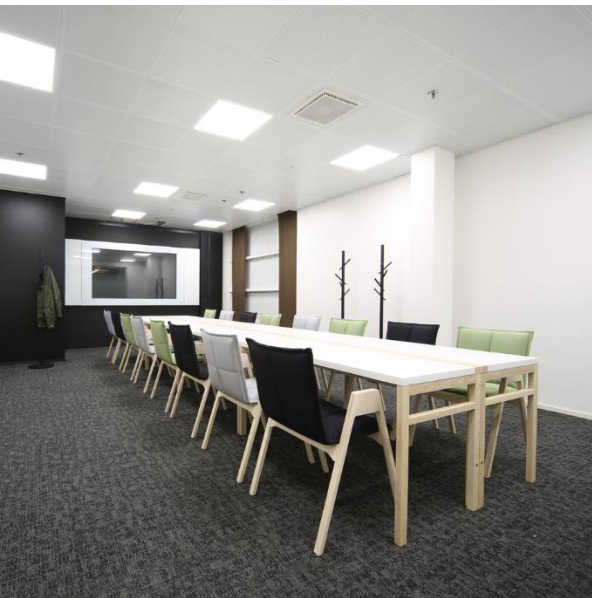

- A totally wooden folding table for multipurpose rooms

Design: Harri Korhonen

inno^{fi}

Intro is a stackable wooden chair for use in a variety of public and private spaces. At first sight Intro looks simple but it is designed with a lot of attention to detail. The unique design combined with ergonomic proportions make it suitable for use in different purposes alone, in a group or around a table. Available with an upholstered seat and/or back.

Design: Ari Kanerva

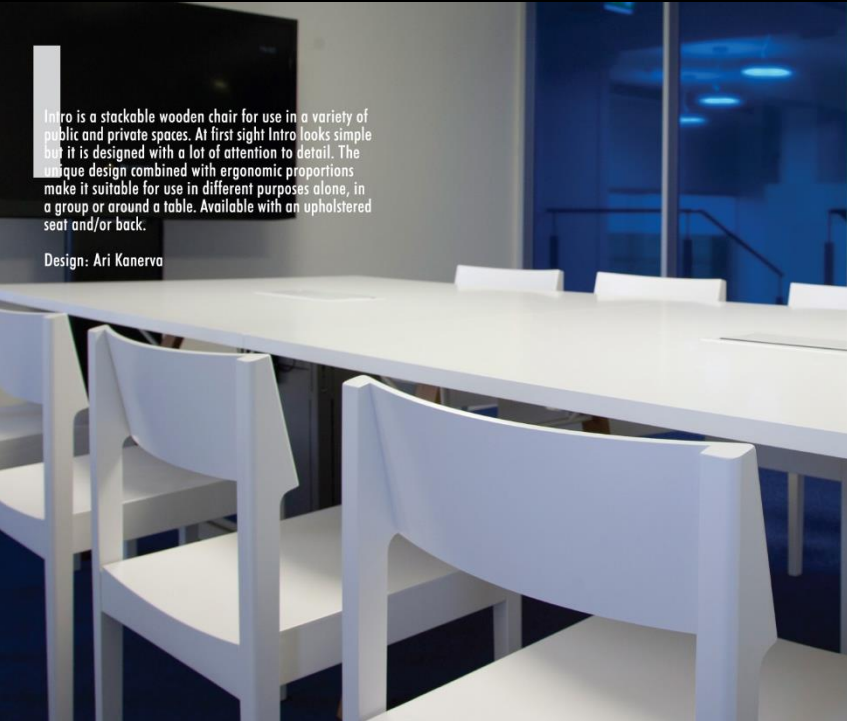

- stackable wooden chair with or without armrests
- available with an upholstered seat and/or back
- non-stackable version "C" launched in Milan 2017

Design: Ari Kanerva

inno^{fi}



BASSO S MEETING



BASSO S

**GOOD
DESIGN**



Basso is a streamlined chair with remarkable sitting comfort. Basso creates discreet reliability and even playful ambience particularly in meeting rooms. It has a lumbar support embedded in the streamlined profile. The upholstered armrest protects the edge of the table top.

Basso is available in four sizes. M, L and XL comes with a 4-star cross leg (X) or a 5-star cross leg with wheels and gaslift (Z). Optional armrest. Basso S is a stackable small chair.

Design: Harri Korhonen

TABLE: CUSTOM MADE



BASSO M xa



BASSO L xb



BASSO XL zb

- maximum comfort in a minimal shape
- four sizes (S, M, L & XL)
- different leg options

Design: Harri Korhonen

inno^{fi}



KOLA STACK ZA



KOLA LIGHT WOOD

- 2010 GOOD DESIGN™ award
- fennia prize 2012
- red dot design award winner 2012

Design: Mikko Laakkonen

inno.fi



KOLA LOUNGE

KOLA



KOLA LOUNGE



KOLA STACK RA + CUSHION

- stacks very well
- fire resistant
- easy to clean

Design: Mikko Laakkonen

inno^{fi}

KOLA

KOLA ROCKING CHAIR



- light weight
- cushions for extra comfort and colours
- Kola Bar launched in Milan 2016

Design: Mikko Laakkonen

inno^{fi}



T

Taivu is a light and youthful, totally upholstered lounge chair for lobbies and waiting areas. It is a generous and comfortable chair seasoned with classic shapes. Taivu is easily tailored to fit different public interiors as well as homes.

Design: Mikko Laakkonen



- Taivu launched in Milan 2014

Design: Mikko Laakkonen

inno^{fi}



Free form, solid, smooth, rounded, peaceful... From earlier lighter Bondo versions Bondo D is the new totally upholstered basic module for Bondo – the universally applicable lounge element for public and semipublic waiting areas. The range of compositions may vary from a bench or divan to a 2-seater sofa, thanks to the different shapes of the back elements. Bondo can be combined into different setups or lines or used as single seats. Design: Harri Korhonen.



BONDO D-3

- 2 different seat options
- freeform backrest options (bench, divan or 2-seater sofa)
- side tables in different sizes and leg options

Design: Harri Korhonen

inno^{.fi}



B

Bondo table was originally designed as part of the Bondo sofa series. The light structure, beveled table top edge and soft shape create an aerial impression. The tables overlap each other slightly which allows for organic layouts. The table is available in five sizes including a small side table to be used as a laptop or writing table in groups that consists of sofas and armchairs.

Design: Harri Korhonen.

BONDO

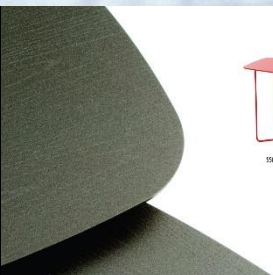

155x124x78



72x45x76 106x54x78



149x45x77

120x51x73

- The light structure and soft shape create an aerial impression
- Several sizes that overlap each other slightly for organic layouts
- Wooden leg version launched in Stockholm 2016



Design: Harri Korhonen

inno^{.fi}



C

C.D. Medium is a new stackable wooden chair in the timeless C.D. family.

Design: Harri Korhonen



C.D. MEDIUM



C.D. Lobby+



C.D. Bar



C.D. Stack Wood



C.D. Sofa



C.D. Table



C.D. Light



C.D. Conference



C.D. Terrace Table



C.D. Stack Table



C.D. Stack



C.D. Stack Terrace



C.D. Stack Bench

• stackable wooden chair in the timeless C.D. family

• upholstered seat and/or back

Design: Harri Korhonen

inno^{fi}



Design: Harri Korhonen

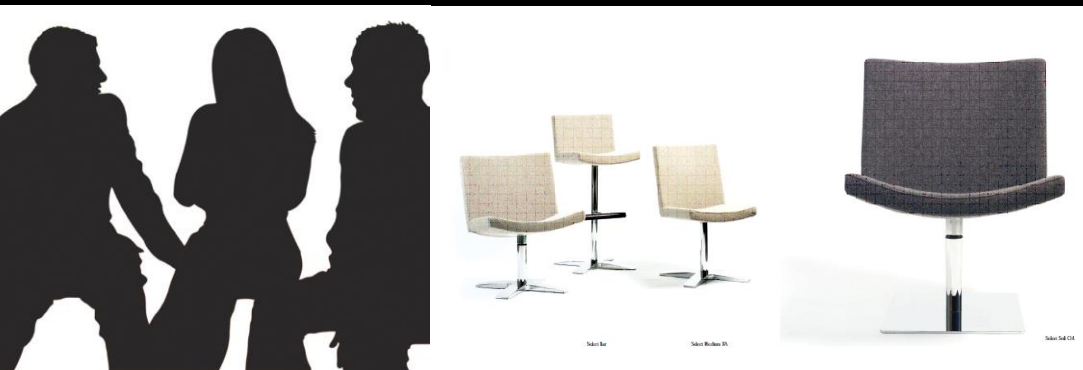

- one of Innos biggest product families
- many different seating and leg options
- one of Innos best sellers
- Select yours

inno^{fi}



SELECT



• The Select chairs are used in Volvo branding world wide



CHAIR: KOLA

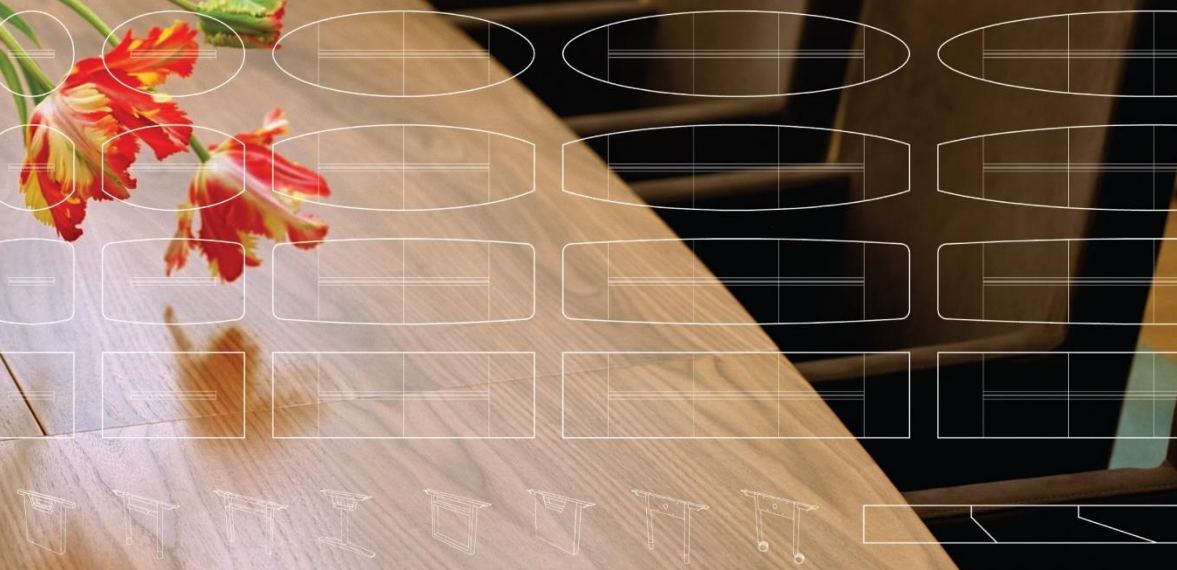

- in-tensive is a forerunner of modular electrified meeting tables, first introduced at Nokia Research Center in 1998



In-tensive is a forerunner of modular electrified meeting tables. First introduced back in 1998 in Nokia Research Center In-tensive has proven itself in meeting rooms all over the world. The modular structure, table tops in different shapes, sizes and materials and a large variety of leg versions make In-tensive suit both modern and classical interiors. All In-tensive tables have a spacious table tray for easy table management and different connections. For total range see separate brochure.

Design: Jouni Leino

CHAIR: INTRO

IN-TENSIVE



CHAIR: JULIE



• modular structure, table tops in different shapes, sizes and materials and a large variety of leg versions.

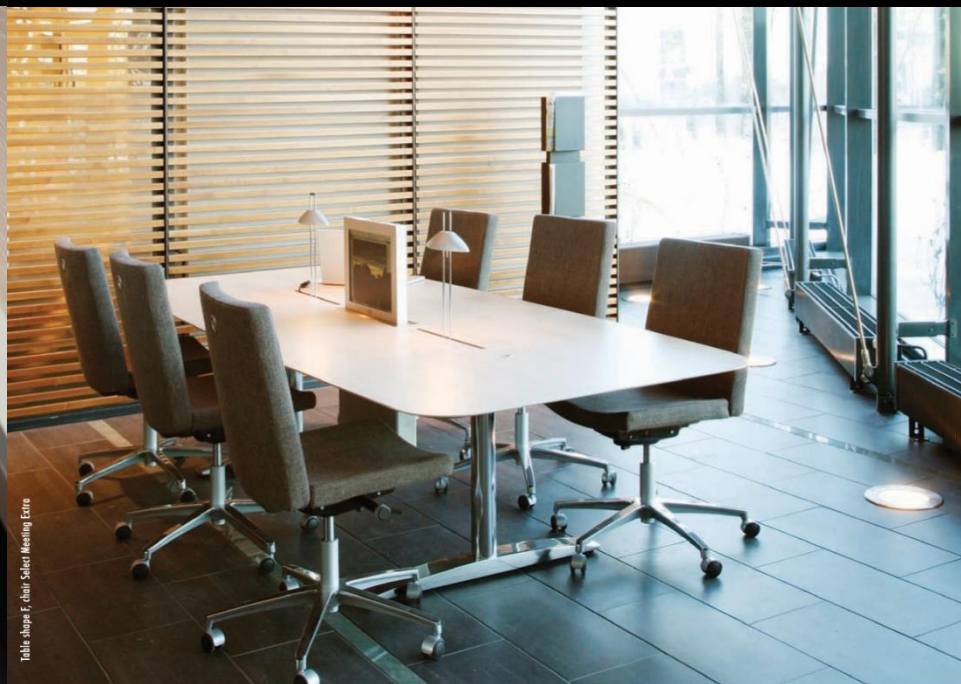
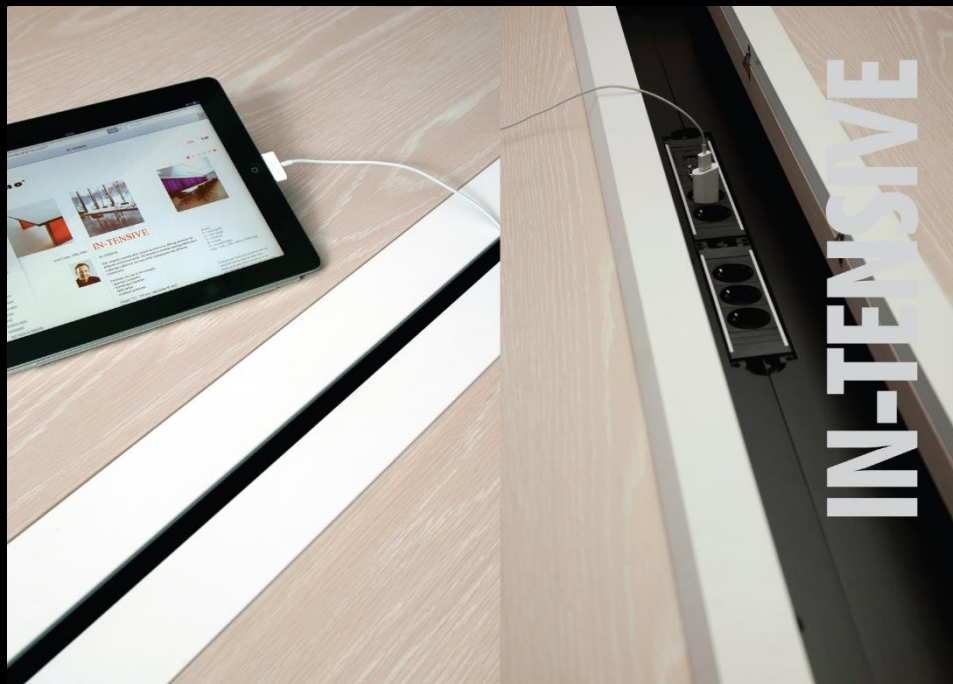

• all tables have a spacious cable tray for easy cable management and different connections.

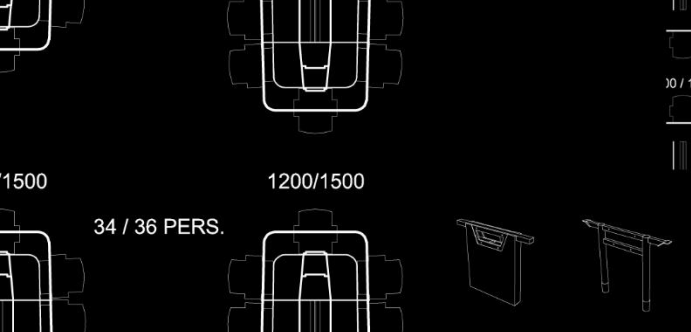
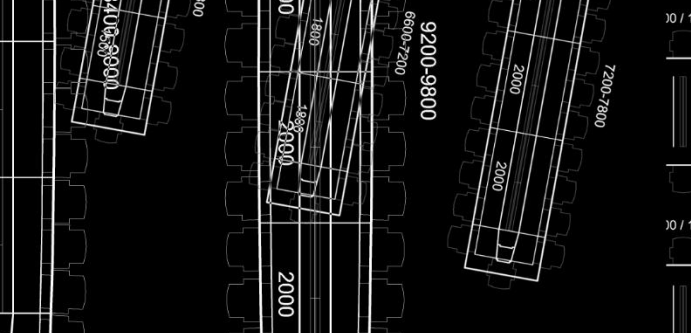
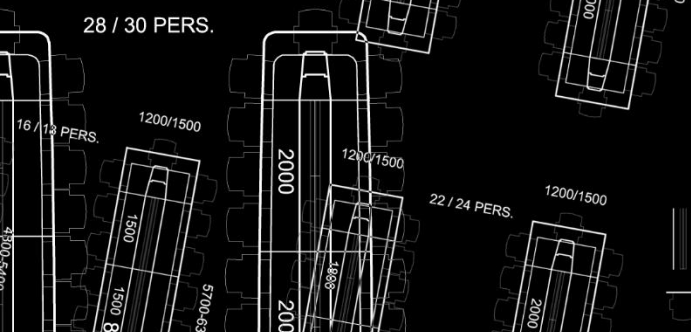
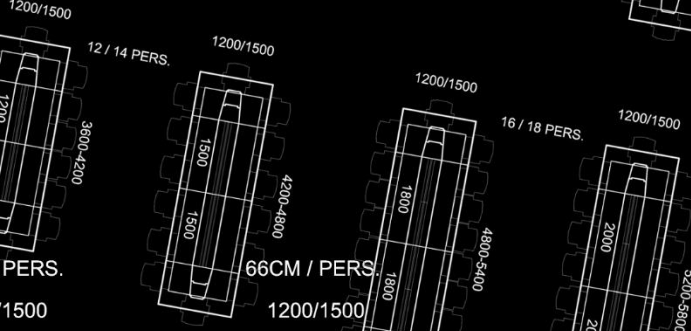

R UNIT

1200 5 PERS.
1100 4 PERS.
1000 4 PERS.

1500 6 PERS.
1400 5 PERS.
1300 5 PERS.



R

2000 8 PERS.
1900 7 PERS.
1800 7 PERS.
1700 7 PERS.
1600 6 PERS.

2400 10 PERS.
2300 9 PERS.
2200 9 PERS.
2100 8 PERS.

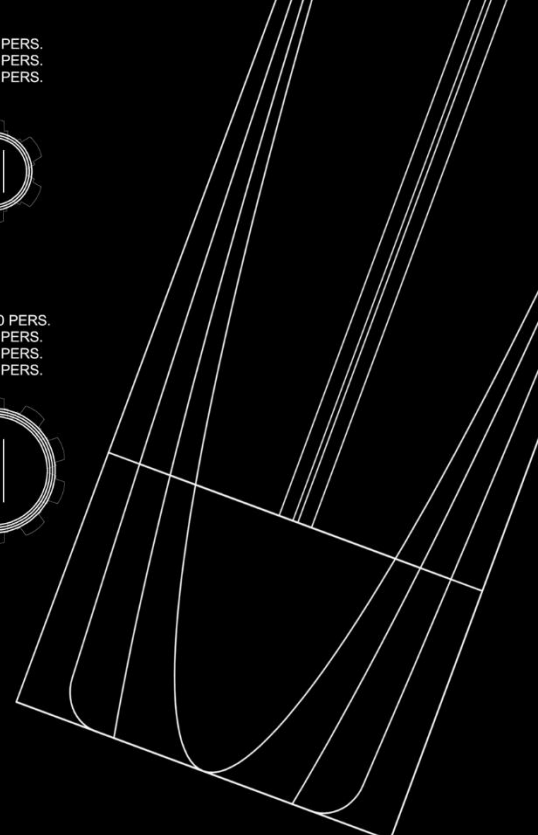
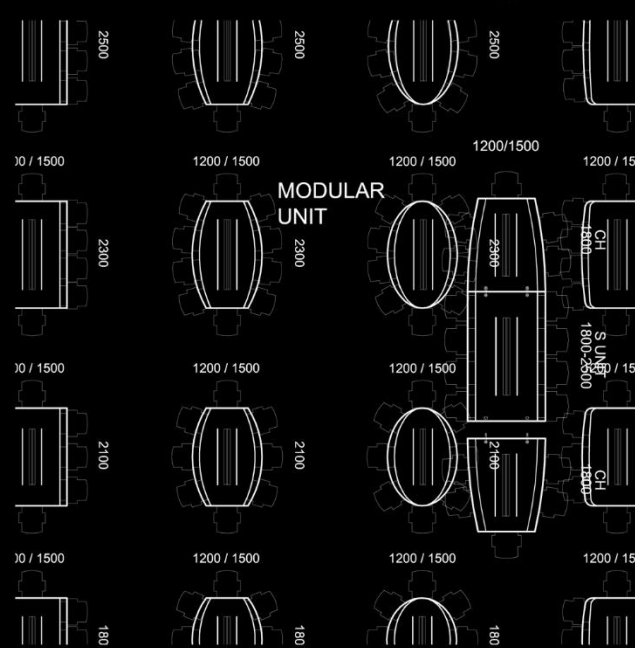
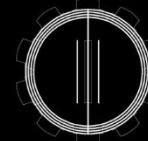
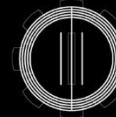
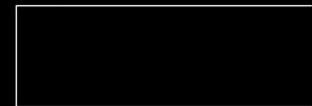
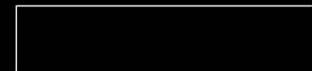

TABLE TOP PROFILES
SCALE 1:2

39mm, STRAIGHT EDGE SR



26mm, STRAIGHT EDGE SR



26mm, BEVELED EDGE MR

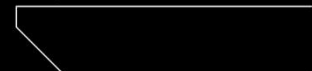

26mm, BEVELED EDGE VR





BOX WOOD



B

Box Wood with wooden legs and soft appearance is a new version of the modular Box sofa system. The sofas and the benches that come in different widths and lengths are presented as part of the Cozy Office concept.

Design: Harri Korhonen





O

Oka comes in three versions: hanging, free standing and as a wall attached coat rack. Oka A hangs from the ceiling in a steel wire, doesn't take floorspace and makes cleaning much easier. It's equipped with 6 hooks and a height adjustment mechanism. The free standing coat rack Oka B is equipped with 6 hooks. The wall attached Oka C coat rack is available with either 3 or 5 hooks. Because of the very small width, there is a good possibility to use Oka C in narrow areas like on pillars. It also works in larger rows.

Design: Teppo Asikainen



OKA

OKA C5

Design: Teppo Asikainen

- innovative design
- Fennia prize



OKA C3



OKA B

inno^{fi}



- launched in Stockholm 2016
- totally wooden coat rack with pegs shaped as truncated cones that penetrate the stem, functioning as hooks

Design: Mikko Laakkonen

inno^{fi}

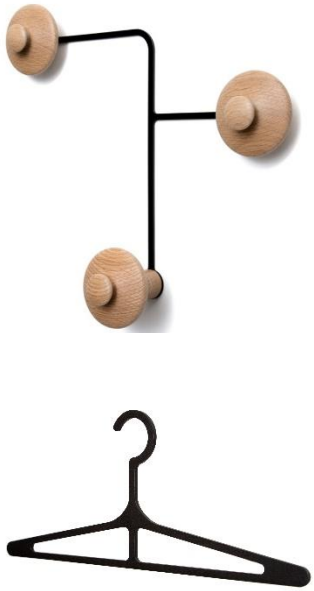

- Turner coat rack with three wooden knobs
- One knob is longer allowing use of a hanger
- Aluminium hanger also available

Design: Susanne Grønlund

inno^{fi}

P

Propel is a simple coat rack with a playful spirit. Its innovative structure and wooden hooks combined with fresh colours make it a much anticipated novelty.

Design: Harri Korhonen



PROPEL

- simple coat rack with a playful spirit

- innovative structure

Design: Harri Korhonen



inno.fi

T

Tripla is a coat rack where shape meets function. The same crown is used in three different ways: in a triple leg or single leg free standing coat rack and as a wall attached hook. In the free standing versions you may use the crown for hanging and even store small items like keys, mobile phones etc. Attached to the wall it can be used simply as a hook or with a coat hanger.

Design: Harri Korhonen



TRIPLA C



TRIPLA



- launched in Milan 2011
- light weight
- use the crown to store small items

Design: Harri Korhonen

inno^{fi}



T

Two Step is a multifunctional coat rack for all kinds of public environments. Two Step is lightweight and very well stackable, making it perfect even for temporary use. It can be easily be connected to each other, has 12 hooks and four pegs for hats and can be used with coat hangers too.

Design: Valvomo/Timo Vierros



- light weight
- good stacking capability
- easy connecting
- perfect even for temporary use



Design: Timo Vierros

inno^{fi}

STANDARD MATERIALS



Birch natural

Ash natural

Maple natural

Oak natural

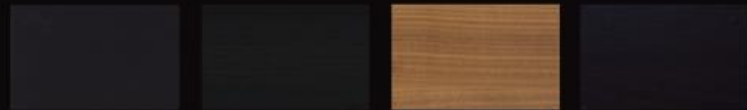

Birch black

Ash black

Walnut natural

Oak black



Birch white

Ash white

Wenge natural

Oak white



Birch grey

Nano white

Nano black

Oak bleached



Laminate grey

Laminate white

Laminate black

PROJECT

Special colours and stains on request

Other finishings



Chromed

Crystal aluminium

Silver aluminium

Metallic grey



Effect white

Matte white

Matte black

Effect black

SELECTED COLOURS



Table: In-tensive, chairs: Intro

In addition to standard materials four selected colours are available for metal and ash.



The actual colours may vary due to natural materials, printing technique and screen calibration.



Ash yellow

Ash red

Ash blue

Ash green



RAL1012 yellow

RAL3002 red

RAL5001 blue

RAL6012 green

SELECTED REFERENCES IN PICTURES



• Fazer Visitor Centre (Helsinki, Finland, 2016) Lab, Julie



- LinkedIn (Stockholm, Sweden, 2015) Jarman, Bondo, Aura



• OP Vallila (Helsinki, Finland, 2015) Lab, Julie



• Airport Ana Lounges 5 & 6 (Lisbon, Portugal, 2015) Select



• Meripaviljonki (Helsinki, Finland, 2015) Kola



• Labquality (Helsinki, Finland, 2015) In-tensive, Basso, Aura



- Borenius (Helsinki, Finland, 2015) In-tensive table, Basso chair

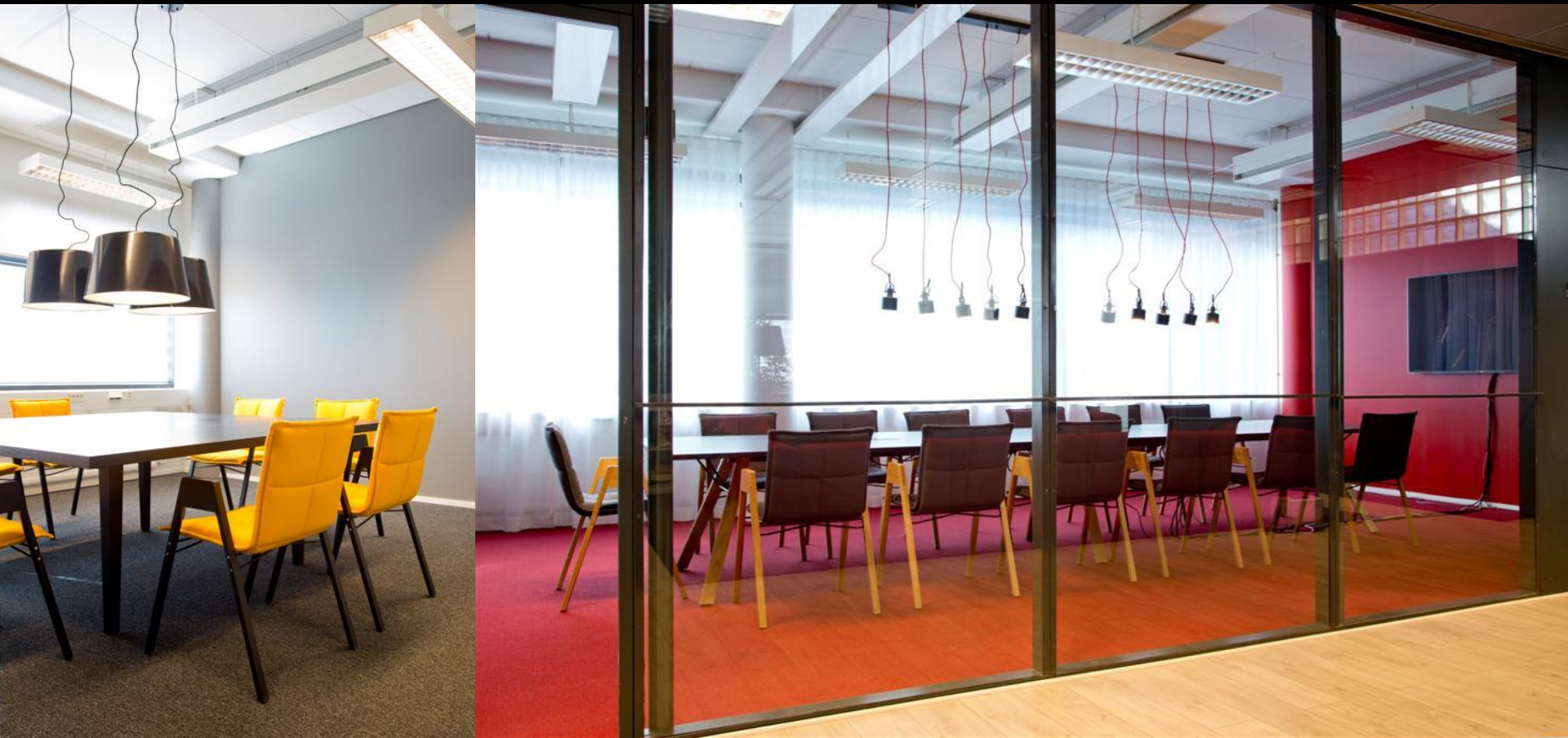

• Tuxera HQ (Helsinki, Finland, 2014) Lab table, Lab chair



• Jayway (Malmö, Sweden, 2013) Aura sofa, Kola Lounge



• Sokos Hotel Torni (Tampere, Finland, 2014) C.D., Lab



• GLO Hotel (Helsinki, Finland, 2013) C.D. Medium, Oka



- The Finnish trade union confederations SAK (Helsinki, Finland, 2011) Basso



- Confederation Of Finnish Industries - EK (Helsinki, Finland, 2012) In-tensive, Basso



- Government Palace (Helsinki, Finland, 2011) In-tensive, Basso



- Service Union United PAM HQ (Helsinki, Finland, 2013) In-tensive, Basso chair



• TNS Gallup (Helsinki, Finland, 2012) Aura sofa



”Mitt *SYNSÄTT* kännetecknas av att den *FYSISKA GESTALTNINGEN* på kontoret ska gå hand i hand med *arbetssättet* och organisationens *MÅL OCH VISION*”

Sökjätten Googles
Stockholmskontor

MAN MÅSTE VÅGA släppa kontrollen över de anställda. Ge dem
möjligheten att mer fritt välja hur de vill jobba, svarar arki-

- Google (Stockholm, Sweden, 2012) Kola, Oka



- Microsoft Europe HQ (Seine Ouest, France, 2010) In-tensive, Select



- Hotel Bora (Germany, 2013) Kola Rocking, Kola Stack, Kola Lounge
- A stacking version of Kola Lounge was developed specially for the Skylounge bar



- Sokos Hotel Villa (Tampere, Finland, 2011) Kola Rocking, Kola Lounge



RESTAURANT

- Lapin Kulta restaurant (Helsinki Airport, Finland, 2010) Kola Lounge

SELECTED REFERENCES

Worldwide

Qatar Airways Offices, Worldwide
Volvo Offices, Worldwide

Europe

Lisbon Airport, Portugal
Microsoft, European head office, France
Casinos in Austria, Austria
International press centre, Belgium
MSC Belgium, Belgium
Concert and Congress Hall, Croatia
Hjorring Rådhus, Denmark
Foreign Ministry of Lithuania, Estonia
Estonian Ministry of Foreign affairs, Estonia
European Parliament, Strasbourg, France
Musee Jaques Chirac restaurant, France
Palais des Justice, Grenoble, France
L'Oreal head office, Paris, France
Grande Stade football stadium, France
Hotel Oceania, Issy Moulineaux, France
Hotel Oceania, Bouquenais, France
Cinema Gaumont, Amiens, France
Wella hairdressers, Germany
Moevenpick, Germany
Congress Hotel Dorint, Germany
Filmpalast am ZKM, Germany
Musical Theater, Germany
Ministry of Finance, Germany
Hotel Zur Linde, Welling, Germany
Radisson SAS, Berlin, Germany
Goethe Institut, München, Germany
Neue Spielbank, Germany
Irish Museum of Modern Art, Ireland
Bank of Ireland Art Centre, Ireland
European Academy, Italy
Gruppo Podino, Torino, Italy
Hotel Liettuva, Vilnius, Lithuania
Palais des Congress Grimaldi Forum, Monaco
DNB, Norway

Google HQ, Stockholm, Sweden
Telenor, Norway
Polar Miljö Institute, Tromsø, Norway
Ericsson Telecom, Moscow, Russia
Sodis, ST.Peterburg, Russia
Parch Hotel, Bucharest, Romania
Loudres ship, Spain
Ghema ship, Spain
Moewenpick, Switzerland
Mc Donalds Hotel, Switzerland
Hotel Astoria, Lucerne, Switzerland
Ericsson, Gothenburg, Sweden
Nordbanken, Sweden
SE banken, Sweden
Tekniska Högskolan, Sweden
Modo Paper, Sweden
ABB, Gothenburg, Sweden
Skanska, Stockholm, Sweden
Sun Microsystems, Stockholm, Sweden
Intentia, Stockholm, Sweden
IRF Institute of Spacephysics, Sweden
Sveriges Television, Sweden
Compaq, Sweden
Gothia Towers, Gothenburg, Sweden
British Airways, United Kingdom
IBM Business Installations, United Kingdom
Standard Chartered Bank, United Kingdom
Business Installations Unit 10, United Kingdom
RBS Royal Banks of Scotland, London

Asia

Essendon Football Stadium, Australia
William Cooper Justice Center, Australia
Gothe Institut, Mandras, India
Public Park, Yokohama, Japan
Senate Building Astana, Kazakhstan
Amiri Divan Palace of Amir, Kuwait
Hotel Peninsula, Bangkok, Thailand
Lexus Tokyo showroom, Japan

North and South America

Adhiseno Cia, Equador
AKZO, Mexico
Clinton Presidential Center, USA
New York Public Library, USA
Trinity University, Texas, USA
Lincoln Jazz Center, USA
Hard Rock Hotel Hollywood, Florida, USA
Tangram Interiors, California, USA
Grandbrook Institute of Science, USA

Finland

OP Vallila HQ, Helsinki, Finland
Fazer Visitor Centre, Helsinki, Finland
Government Palace, Helsinki, Finland
Destia Oy, Helsinki
City of Espoo
City of Helsinki
City of Joensuu
City of Kuopio
City of Turku
Elisa Oyj, Helsinki
Finnair Oy, Vantaa
Capgemini Finland, Helsinki
Kiasma, Modern Art Museum, Helsinki
Ministry of Education, Helsinki
Ministry of Finance, Helsinki
Ministry of Foreign Affairs
NCC Rakennus ja Property, Helsinki
Nokia Oyj, Helsinki
Sampo Bank, all offices in Finland
Scandic Hotel Espoo
Scandic Hotel Grand Marina, Helsinki
Scandic Hotel Oulu
Scandic Hotel Tampere
TeliaSonera Oyj, Helsinki
University of Helsinki, Tampere and Turku

SELECTED HOTEL REFERENCES

Hotel Bora, Germany
Hotel Hilton in Copenhagen, DK
Comwell Conferencre Hotels, DK
Hotel Viru, Tallinn, Estonia
Hotel Mercure, Angers, France
Hotel Ville d'Épinay sur Seine, France
Hotels Oceania
Hotel de Ville, Pontivity, France
Holiday Inn, Frankfurt
Dorint Hotel, Binz, Germany
Hotel Crown Plaza, Berlin
Congress Hotel Dorint, Hamburg
Kult Hotel, Germany
Hotel Zur Linde Welling, Moers-Repelen, Germany
Radisson SAS, Berlin
Dorint Hotel München
Suite Hotel Hannover
Novotel, Mainz, Germany
Royal York Hotel, UK
The Palace Hotel, Manchester, UK
Rushbrook Hotel, Ireland
Holiday Inn, Dublin, Ireland
Lough Allen Hotel co Leitrim, Ireland
Sligo Park Hotel, Ireland
Clarion Hotel Dublin, Ireland
Carton Hotel, Dublin, Ireland
Castle Dárgen Hotel, Ireland
Kilmainham Hotel, Ireland
Reval Hotel, Riga, Latvija
Hotel Liettuva, Vilnius
Palais des Congress, Monaco
Torbjornsrud Hotel, Norge
Parc Hotel, Bucharest, Romania
Grand Hotel, Stockholm, Sweden
Scandic Hotels, Sweden
First Hotels, Sweden
Hotel Lady's First, Switzerland
McDonalds Hotel. Lully, Switzerland
McDonalds Hotel, Rumland, Switzerland
Hotel Astoria, Switzerland
Hotel Peninsula, Bangkok, Thailand
Hotel Doubletree, NY, USA
Hard Rock Hotel, Hollywood, Florida, USA
Caribbean Cruisers
Ramada, Yekaterinburg Russia



Lab 2015
 Aura 2015
 Julie 2015
 Naula 2016
 Basso Y 2016



Kola 2012

Aura sofa 2013

AWARDS



Kola 2012



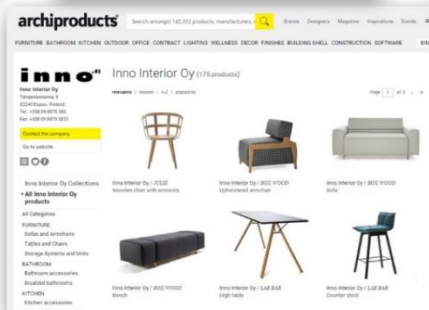
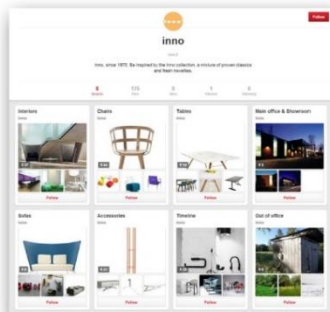
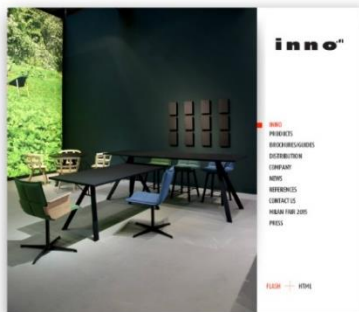

inno.fi for more information about us and the designers we are working with. Find out more about our products, materials and dimensions, high resolution press photos, brochures, cad files, product news, events, references and distributors near you. www.inno.fi.

You can also find us on Architonic, Archiprotects, Facebook & Pinterest.

- www.inno.fi
- architonic
- archiprotects
- linkedin
- facebook
- pinterest

Thank You!

inno^{.fi}

INNO INTERIOR OY TÄHDENLENNONTIE 9 02240 ESPOO FINLAND www.inno.fi info@inno.fi T. +358 9 8870380 F. +358 9 88703833